

# UNIFIX 150 B



- |           |                                   |         |
|-----------|-----------------------------------|---------|
| <b>FR</b> | <b>Le support basique</b>         | p.2-6   |
| <b>EN</b> | <b>The basic mounting bracket</b> | p.7-11  |
| <b>ES</b> | <b>El soporte basico</b>          | p.12-16 |
| <b>IT</b> | <b>Il supporto basico</b>         | p.17-21 |

Cher client, nous vous remercions pour votre achat de l'un de nos produits uniteck. Veuillez lire avec attention toutes les instructions avant d'utiliser le produit.

## DESCRIPTION

Les supports Unifix ont été conçus spécialement pour fixer vos panneaux photovoltaïques Unisun ou équivalents (cf partie panneaux compatibles):

- Unifix 150 B pour vos panneaux Unisun 150.12M / 150.12BC ou panneaux jusqu'à 700 mm de largeur

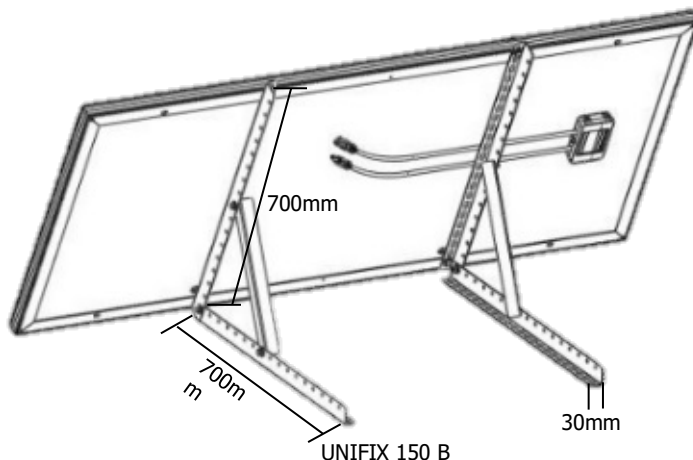

Simple à installer, il se fixe sur une surface plane rigide à l'horizontale ou à la verticale (ex: mur, sol béton, ossature bois).

Grâce à leur structure en acier galvanisé et leur visserie en inox résistant à la corrosion, ils sont parfaitement adaptés pour un usage en extérieur.

Dotés du système d'inclinaison multi-position, les supports Unifix vous permettent d'optimiser vos performances en fonction de l'orientation choisie.

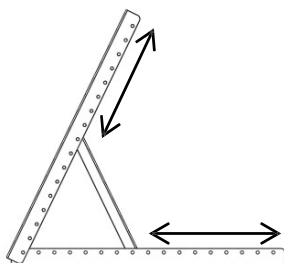

**Performance électrique en fonction de l'inclinaison et de l'orientation panneau**

	0°	30°	60°	90°
<b>Est</b>	93%	90%	78%	55%
<b>Sud-Est</b>	93%	96%	88%	66%
<b>Sud</b>	93%	100%	91%	68%
<b>Sud Ouest</b>	93%	96%	88%	66%
<b>Ouest</b>	93%	90%	78%	55%

Pour réaliser la connexion panneau/régulateur/batterie, nous vous recommandons d'utiliser le kit prêt à l'emploi Uniconnect 1.6 qui optimise vos performances électriques et simplifie le montage (kit de connexion 1 panneau).

## UNIFIX 150B

### PANNEAUX COMPATIBLES

Grâce à son design adaptatif, Unifix permet la fixation de différents panneaux du marché.

Unifix 150B accepte 1 panneau, avec les entraxes et dimensions panneaux comme indiquées ci-dessous.

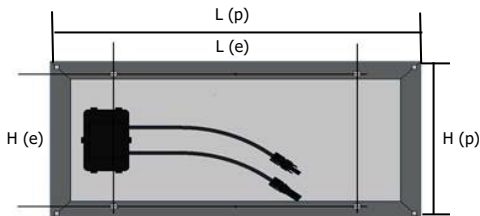

Entraxe et dimensions panneau

	Nbre de panneaux	Entraxes pour la fixation de chaque panneau (en mm)		Dimension panneau maxi		Poids Total maxi panneaux (en Kg)
		L (e)	H (e)	L (p)	H (p)	
<b>Unifix 150B</b>	•	Pas de maxi	100 > 670	pas de maxi	700	20

### RECOMMANDATIONS

Montez les supports Unifix uniquement sur des surfaces présentant une portance suffisante. Tenez compte de la charge supplémentaire avec panneau :

Support	Panneau
Unifix 150 B = 2,5 kg	Unisun 150.12M / 150.12BC =9,8kg / 9,3kg

**Fixation** : pour éviter que de grandes quantités de neige ne s'accumulent derrière le capteur, installez en amont des grilles d'arrêt appropriées.

La disposition des capteurs influence vos performances électriques. Choisissez l'inclinaison et l'orientation la plus optimale en fonction de votre environnement. Evitez les zones d'ombre ou que certains objets ne soient source d'ombre (ex. arbre)

### CONSIGNES DE SÉCURITÉ

- Prenez les mesures appropriées pour prévenir les accidents pendant vos travaux de montage.
- Si le support et le matériel de montage sont exposés aux rayons du soleil pendant une longue période, il y a un risque de brûlure. Protégez-vous.
- A la fin des travaux, vérifiez que vos supports et panneaux soient bien fixés

**Couple de serrage préconisé**

Nb. Coefficient de frottement moyen  $\mu=0,20$  / Serrage à 50% de la limite élastique

Vis	Couple
M5	5,10 Nm
M 6	8,80 Nm
M 8	21,50 Nm
M 10	44,00 Nm

- Fixez les 2 pièces n°38 sur le cadre de votre panneau solaire Unisun en fonction de la largeur de votre panneau (cf schéma ci-dessous). Pré-serrez les écrous. Le serrage définitif sera réalisé à la fin de l'assemblage.

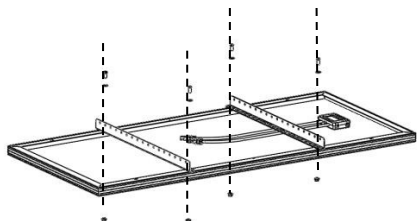

Largeur panneau < 700 mm

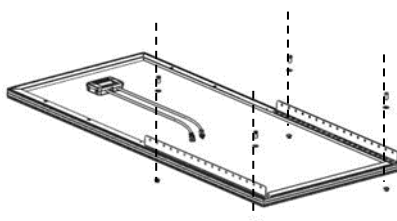

Largeur de 700 mm à 1000mm

			
M8 <b>X4</b>	D8 <b>X4</b>	M8 <b>X4</b>	N°38 <b>X1</b>

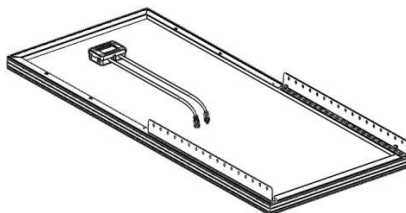
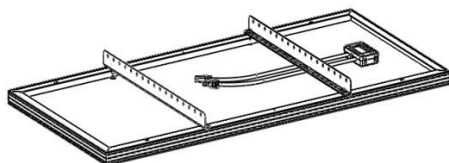



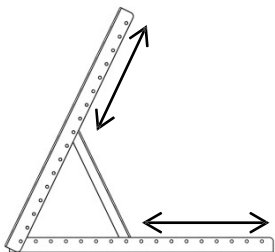

## UNIFIX 150 B





- Unifix dispose d'un système d'inclinaison multi-positions. Définissez l'inclinaison souhaitée en fonction de l'orientation choisie.



Performance électrique en fonction de l'inclinaison et de l'orientation panneau

	0° 	30° 	60° 	90° 
<b>Est</b>	93%	90%	78%	55%
<b>Sud-Est</b>	93%	96%	88%	66%
<b>Sud</b>	93%	100%	91%	68%
<b>Sud Ouest</b>	93%	96%	88%	66%
<b>Ouest</b>	93%	90%	78%	55%

- Fixez les 2 pièces N°38 et N°37 en fonction de l'inclinaison choisie.

	M8x20 <b>X6</b>
	D8 <b>X6</b>
	M8 <b>X6</b>
	N°38 <b>X2</b>
	N°37 <b>X2</b>

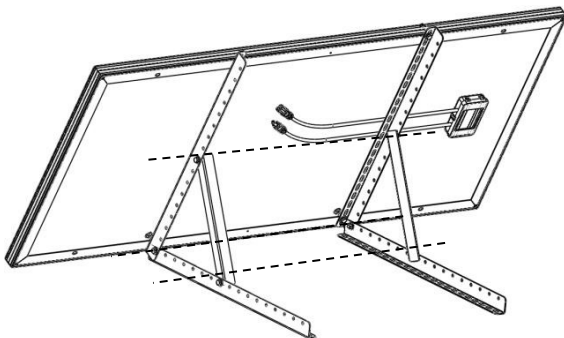

- Fixez l'ensemble sur votre surface plane (sol dur ou mur rigide) avec 10 vis adaptées à votre surface (vis et chevilles non fournies).

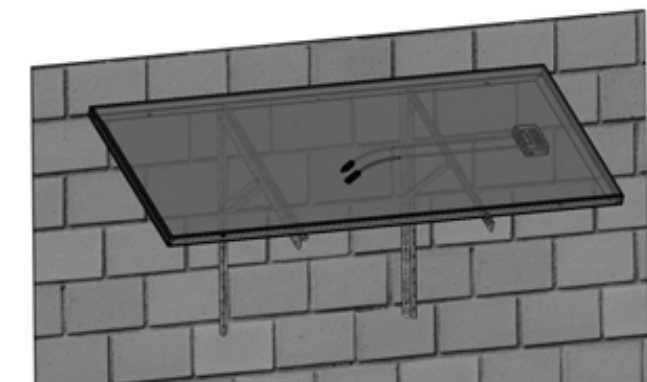

## GARANTIE

La garantie couvre tout défaut ou vice de fabrication pendant 1 an, à compter de la date d'achat (pièces et main d'œuvre).

La garantie ne couvre pas :

- l'usure normale des pièces
- les erreurs de montage

En cas de défauts, retournez le produit à votre distributeur, en y joignant :

- un justificatif d'achat daté (ticket de sortie de caisse, facture...)
- une note explicative du défaut.

Attention : notre SAV n'accepte pas les retours en port dû.

Après la garantie, notre SAV assure les réparations après acceptation d'un devis.

Contact SAV :

UNITECK  
3 Avenue de l'Europe  
34310 Montady  
France  
mail: [sav@uniteck.fr](mailto:sav@uniteck.fr)

Dear customer, thank you for purchasing one of our Uniteck products. Please read all the instructions carefully and thoroughly before using the product.

## DESCRIPTION

Unifix brackets have been specially designed to fix your Unisun photovoltaic panels or equivalent (see compatible panels part):

- Unifix 150 B for your Unisun 150.12M / 150.12BC panels or panels with a width of up to 700 mm.

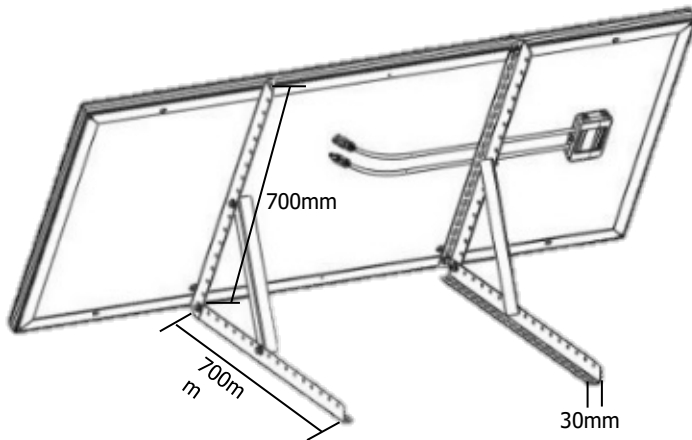





UNIFIX 150 B

Easy to install, Unifix 100B can be fixed on a horizontal or vertical rigid flat surface (e.g. wall, concrete floor, wood frame).

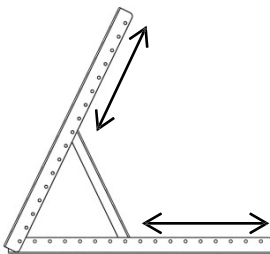
With their galvanized steel structure and corrosion-resistant stainless-steel screws, they are perfectly suited for outdoor use.

Equipped with a multi-position tilting system, Unifix brackets allow for an optimization of your panel's performance depending on the chosen orientation.



Electrical performance depending on tilt and panel orientation				
	0° 	30° 	60° 	90° 
<b>Est</b>	93%	90%	78%	55%
<b>Sud-Est</b>	93%	96%	88%	66%
<b>Sud</b>	93%	100%	91%	68%
<b>Sud Ouest</b>	93%	96%	88%	66%
<b>Ouest</b>	93%	90%	78%	55%

To connect the the panel / regulator / battery, we recommend that you use the Uniconnect 1.6 ready-to-use kits that optimizes your electrical performance and simplifies installation (kit for connecting 1 panel)

# UNIFIX 150B

## PANEL COMPATABILITY

Thanks to its adaptive design, Unifix allows the fixing of different panels on the market.

Unifix 150B accepts 1 panel, with the panel spacing and dimensions as shown below.

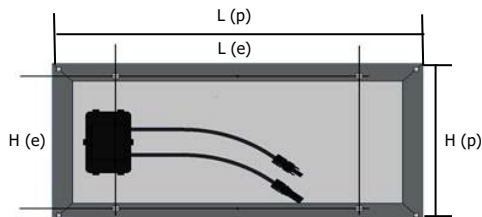

Centre distance and panel dimensions

	Number of panels	Spacers for fastening of each panel (in mm)		Panel Dimension Max		Total weight Of panels (In Kg)
		L (e)	H (e)	L (p)	H (p)	
<b>Unifix 150B</b>	•	Pas de maxi	100 > 670	pas de maxi	700	20

## RECOMMENDATIONS

Mount Unifix brackets only on surfaces with sufficient bearing capacity. Consider the additional load with the panel:

Support	Panels
Unifix 150 B = 2,5 kg	Unisun 150.12M / 150.12BC =9,8kg / 9,3kg

**Fastening:** to prevent large quantities of snow from accumulating behind the sensor, install appropriate barrier grids.

The position of the solar panel influences your electrical production. Choose the most optimal inclination and orientation to suit your environment. Avoid shaded areas or objects that are a source of shadow (eg tree)

## SAFETY INSTRUCTIONS

- Take the appropriate mesures to prevent accidents during your mounting steps.
- If the bracket and the mounting tools are exposed to sunlight for a long period, there is a risk of getting burnt. Make sure to protect yourself accordingly.
- When finished, check and ensure that all of your brackets and panels are fixed properly

## UNIFIX 150 B

### Recommended tightening torque

Nb. Mean coefficient of friction  $\mu=0.20$  / Clamping at 50% of yield point

Screw	Torque
M5	5,10 Nm
M 6	8,80 Nm
M 8	21,50 Nm
M 10	44,00 Nm



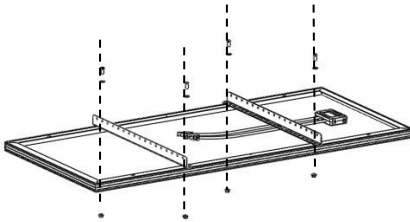

- Fix the 2 n°38 pieces on the frame of your Unisun solar panel according to the width of your panel (see diagram below). Pre-tighten the nuts. The final tightening will be done at the end of the assembly.

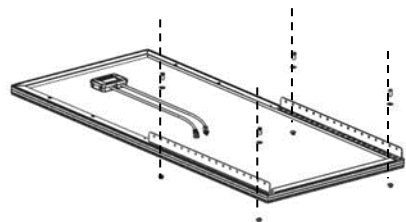

Panel width < 700 mm



Width from 700 mm to 1000 mm

			
M8 <b>X4</b>	D8 <b>X4</b>	M8 <b>X4</b>	N°38 <b>X1</b>

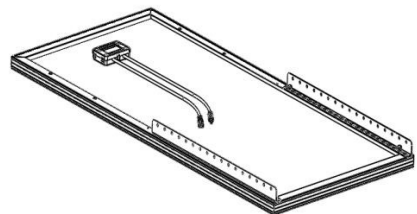
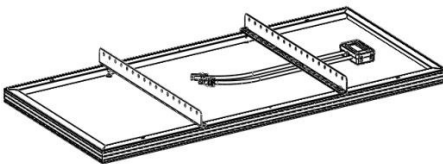



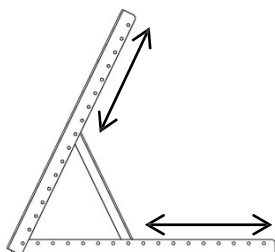

## UNIFIX 150 B

- Unifix is equipped with a multi-position tilt system. (10 positions). Set the desired tilt depending on the desired orientation.

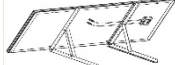

Electrical performance depending on tilt and panel orientation				
	0°	30°	60°	90°
<b>Est</b>	93%	90%	78%	55%
<b>Sud-Est</b>	93%	96%	88%	66%
<b>Sud</b>	93%	100%	91%	68%
<b>Sud Ouest</b>	93%	96%	88%	66%
<b>Ouest</b>	93%	90%	78%	55%

- Fix the 2 pieces n°38 and n°37 according to the chosen inclination.

	M8x20 <b>X6</b>
	D8 <b>X6</b>
	M8 <b>X6</b>
	N°38 <b>X2</b>
	N°37 <b>X2</b>

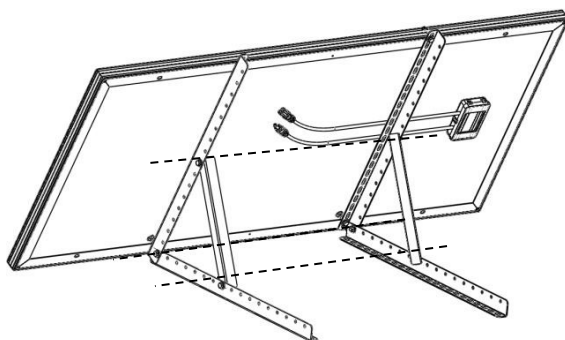

- Fix your bracket with 10 screws adapted to the supporting surface (screws and dowels not supplied).



## WARRANTY

The warranty covers any defect, manufacturing flaws for 1 year from the date of its purchase (Pieces and workforce).

Warranty does not cover:

- normal wear of parts
- faulty mounting of bracket

In case of failure, return the product to your distributor by attaching:

- the dated proof of purchase (receipt, bill...)
- explanatory note of the failure

Caution: Our after-sales service does not accept carriage forward/ collected returns.

After the warranty, our after-sales service ensures repairs after acceptance of a quotation.

After-sales service contact :

UNITECK

3 Avenue de l'Europe

34310 Montady

France

E-mail : [sav@uniteck.fr](mailto:sav@uniteck.fr)

Estimado cliente, gracias por comprar nuestro producto Uniteck. Por favor lea con cuidado todas las instrucciones antes de usar el producto.

## UNIFIX 150 B

Los soportes Unifix están concebidos especialmente para fijar sus paneles Unisun o equivalentes:

- Unifix 150 B para sus paneles Unisun 150.12M / 150.12BC o paneles de hasta 700 mm de ancho.

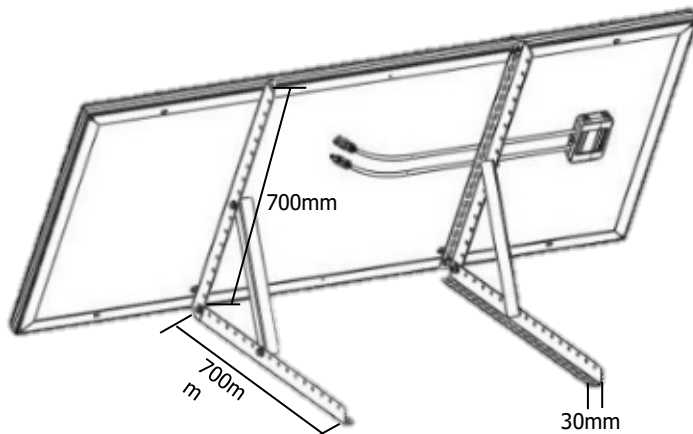

UNIFIX 150 B

Sencillos de instalar, se fije sobre una superficie plana con orientación horizontal o vertical (ej.: pared, suelo hormigón, estructura de madera, césped, ...).

Gracias a su arquitectura en acero galvanizado y su tornillería en Inox resistente a la corrosión, está perfectamente adaptado para un uso exterior.

Dotados del sistema de inclinación multi posición, los soportes Unifix le permite optimizar sus rendimientos en función de la orientación elegida.

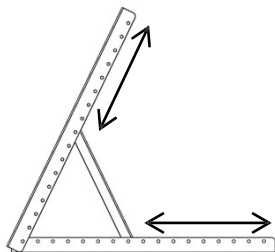

Rendimiento eléctrico en función de la inclinación y de la orientación panel				
	0°	30°	60°	90°
<b>Este</b>	93%	90%	78%	55%
<b>Sur-Este</b>	93%	96%	88%	66%
<b>Sur</b>	93%	100%	91%	68%
<b>Sur Oeste</b>	93%	96%	88%	66%
<b>Oeste</b>	93%	90%	78%	55%

Para realizar la conexión panel/regulador/batería, le recomendamos usar los kits listos para el uso Uniconnect 1.6 conexión 1 panel que optimizan sus rendimientos eléctricos y simplifican el montaje

## UNIFIX 250 B

### PANELES COMPATIBLES

Gracias a su diseño basado sobre el uso de la perforación Oblong, Unifix permite la fijación de diferentes paneles del mercado.

Unifix 250B acepta 1 o 2 panel(es), con las entrevías y dimensiones paneles indicados más abajo.

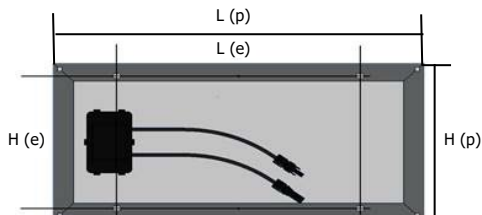

Distancia entre ejes y dimensiones del panel

	Número de paneles	Distancias entre ejes para la fijación de cada panel (en mm)		Tamaño del panel máx		Peso total máx. paneles (en Kg)
		L (e)	H (e)	L (p)	H (p)	
<b>Unifix 150B</b>	•	No máx	100 > 670	No máx	700	20

### RECOMENDACIONES

Fije los soportes Unifix únicamente sobre superficies con una sustentación suficiente. Tenga en cuenta la carga adicional del panel:

Soporte	Panels
Unifix 150 B = 2,5 kg	Unisun 150.12M / 150.12BC = 9,8kg / 9,3kg

Fijación: para evitar que importantes cantidades de nieve se acumulen detrás del sensor, primero instale una rejilla apropiada para parar la nieve

La disposición de los sensores influye sus rendimientos eléctricos. Elija una inclinación y una orientación optima en función de su medio ambiente. Evite las zonas de sombra o que algunos objetos estén origen de sombra (ej.: árbol)

### CONSIGNAS DE SEGURIDAD

- Tome las medidas apropiadas para prevenir los accidentes durante su trabajo de montaje.
- Si el soporte y equipamiento de montaje están expuestos a los rayos del sol durante una larga duración, hay un riesgo de quemadura. Protéjase.
- En fin, de los trabajos, verifique que sus soportes y paneles están bien fijados.

## UNIFIX 150 B

## Par de apriete preconizado

Nb. Coeficiente de fricción medio  $\mu=0,20$  / Presión al 50% de la limita elástica

Tornillo	Par
M5	5,10 Nm
M 6	8,80 Nm
M 8	21,50 Nm
M 10	44,00 Nm

- Fije las dos piezas n°38 sobre el cuadro de su panel solar Unisun en función de la ancha de su panel (cf esquema más abajo). Pre-apreté las tuercas. La presión definitiva estará realizada en fin de combinación.

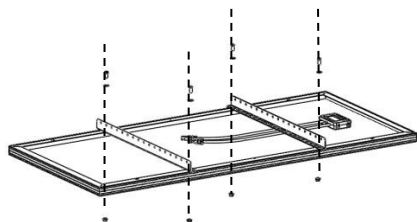

Ancho panel < 700 mm

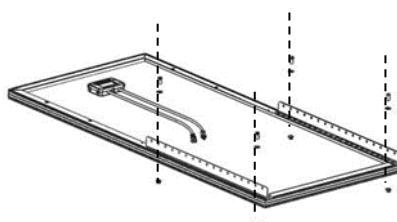

Ancha desde 700 mm hasta 1000

			
M8 <b>X4</b>	D8 <b>X4</b>	M8 <b>X4</b>	N°38 <b>X1</b>

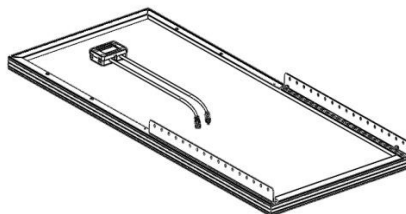
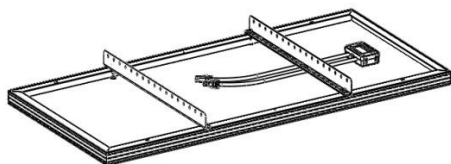

**UNIFIX 150 B**

- Unifix dispone de un sistema de inclinación multi-posición. Defina la inclinación deseada en función de la orientación elegida.

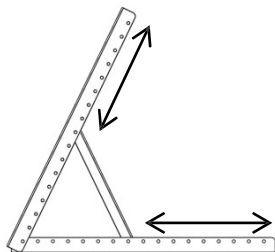

Rendimiento eléctrico en función de la inclinación y de la orientación panel				
	0°	30°	60°	90°
<b>Est</b>	93%	90%	78%	55%
<b>Sud-Est</b>	93%	96%	88%	66%
<b>Sud</b>	93%	100%	91%	68%
<b>Sud Ouest</b>	93%	96%	88%	66%
<b>Ouest</b>	93%	90%	78%	55%

- Fije las 2 piezas N°38 y N°37 en función de la inclinación elegida.

	M8x20 <b>X6</b>
	D8 <b>X6</b>
	M8 <b>X6</b>
	N°38 <b>X2</b>
	N°37 <b>X2</b>

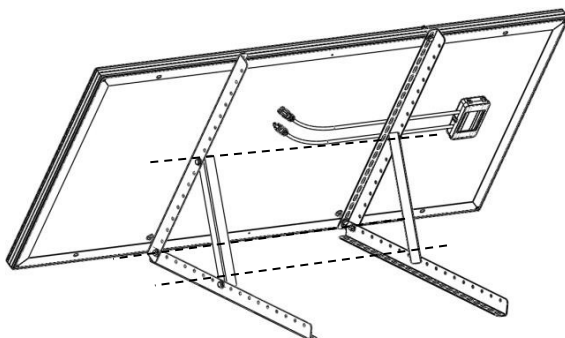

- Fije el conjunto sobre su superficie plana (suelo duro o pared rígida) con 10 tornillos adaptados a su superficie (tornillos y clavijas no provistos).

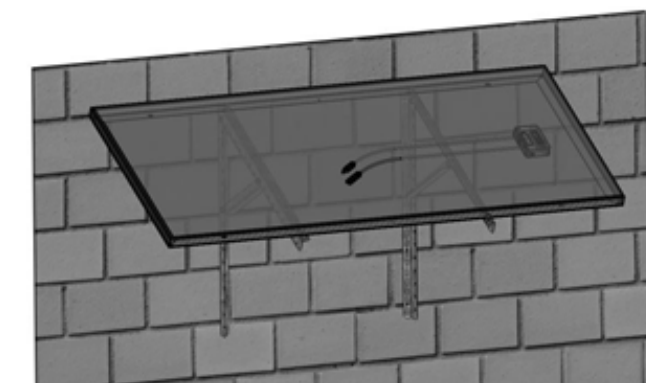

La garantía cubra todo defecto o todo vicio de fabricación durante 1 año, a partir de la fecha de compra (piezas y mano de obra)

La garantía no cubre :

-el desgaste normal de las piezas

En caso de avería, devuelva el aparato a su distribuidor, con :

- un justificado de compra con fecha (tiquete de caja central, factura, ...)

- una nota explicativa de la avería

**Cuidado : nuestro Servicio Postventa no acepta devoluciones a portes debidos.**

Después la garantía, nuestro Servicio Postventa asegura las reparaciones después aceptación de un presupuesto.

Contacto SAV :

UNITECK

3 Avenue de l'Europe

34310 Montady

France

France mail: [sav@uniteck.fr](mailto:sav@uniteck.fr)

Gentile cliente, la ringraziamo per il suo acquisto di uno dei nostri prodotti UNITECK. La preghiamo di prendere conoscenza attentamente di tutte le istruzioni, prima di utilizzare il prodotto.

## DESCRIZIONE

I supporti Unifix sono stati progettati specialmente per fissare i vostri pannelli fotovoltaico Unisun o equivalenti (cfr parte pannelli compatibili):

- Unifix 150 B per i vostri pannelli Unisun 150.12M / 150.12BC o pannelli fino a 700 mm in larghezza

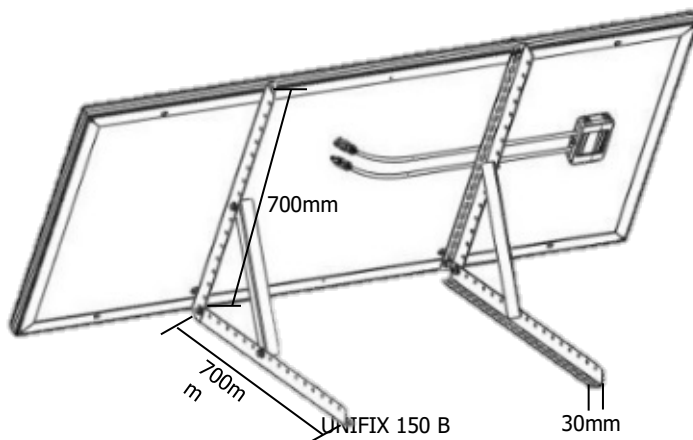

Semplice da installare, si può fissare su una superficie piana rigida orizzontalmente o verticalmente (p.es: muro, suolo cemento, ossatura legno).

Grazie alla loro struttura in acciaio zincato e le viti in acciaio inossidabile resistente alla corrosione, sono perfettamente adatti per un uso esterno.

Dotati del sistema d'inclinazione multi posizione, i supporti Unifix vi permettono di ottimizzare la vostra in funzione dell'orientamento scelto.

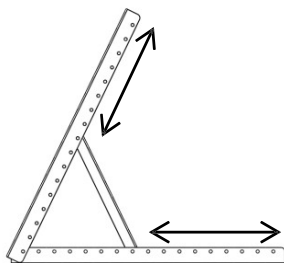

Efficienza elettrica in funzione dell'inclinazione e dell'orientamento pannello				
	0°	30°	60°	90°
<b>Est</b>	93%	90%	78%	55%
<b>Sud-Est</b>	93%	96%	88%	66%
<b>Sud</b>	93%	100%	91%	68%
<b>Sud Ovest</b>	93%	96%	88%	66%
<b>Ovest</b>	93%	90%	78%	55%

Per effettuare il collegamento pannello/regolatore/batteria, vi raccomandiamo di utilizzare il kit pronto all'uso Uniconnect 1.6 che ottimizza la vostra efficienza elettrica e semplifica il montaggio (kit di collegamento 1 pannello).

## UNIFIX 150B

### PANNELLI COMPATIBILI

Grazie al suo design adattativo, Unifix permette il fissaggio di differenti pannelli del mercato.

Si può fissare sull'Unifix 150B, 1 pannello, con interassi e dimensioni pannello come indicato di cui sotto.

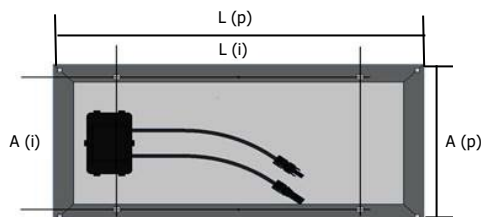

Interasso e dimensioni pannello

	Numero di pannelli	Interassi per il fissaggio di ogni pannello (in mm)		Dimensioni pannello massimo		Peso totale massimo pannello (in Kg)
		L (i)	A (i)	L (p)	A (p)	
<b>Unifix 150B</b>	•	Nessun minimo	100 > 670	Nessun massimo	700	20

### RACCOMANDAZIONI

Montare i supporti UNIFIX solo su superfici che hanno la capacità di sopportare il loro peso. Tenere conto del peso aggiuntivo del pannello

Supporto	Pannello
Unifix 150 B = 2,5 kg	Unisun 150.12M / 150.12BC =9,8kg / 9,3kg

**Fissaggio** : Per evitare che si accumuli una grande quantità di neve dietro il sensore, installare una griglia fermaneve.

La disposizione dei sensori influenza l'efficienza elettrica. Scegliere l'inclinazione e l'orientamento più ottimali in funzione del vostro ambiente. Evitare le zone ombreggiate o che certi oggetti nascondano il pannello (p.es: Albero)

### ISTRUZIONI DI SICUREZZA

- Prendere le misure adeguate per prevenire gli incidenti durante i vostri lavori di montaggio.
- Se il supporto e il materiale di montaggio sono esposti al sole per un lungo periodo di tempo, esiste un rischio di ustione. Proteggetevi.
- Alla fine dei lavori, verificare che i vostri supporti i pannelli siano ben fissati.

## UNIFIX 150 B

### Coppia di serraggio raccomandata

Nb. Coefficiente di attrito medio  $\mu=0,20$  / Serraggio al 50% del limite elastico.

Vite	Coppia
M5	5,10 Nm
M 6	8,80 Nm
M 8	21,50 Nm
M 10	44,00 Nm

- Fissare i 2 pezzi n°38 sul telaio del vostro pannello fotovoltaico Unisun in funzione della larghezza del vostro pannello (cfr schema di cui sotto). Preserrare i dadi. Il serraggio definitivo sarà effettuato alla fine del montaggio.

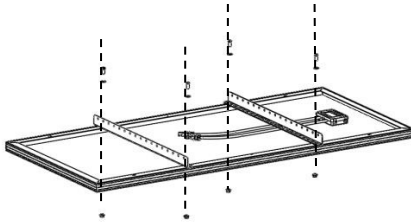

Larghezza pannello < 700 mm

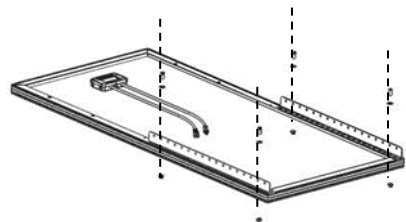

Larghezza da 700 mm a 1000mm



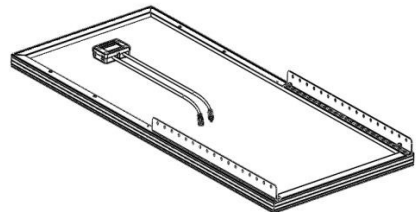
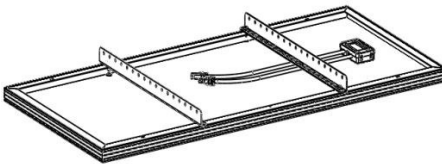

			
M8 <b>X4</b>	D8 <b>X4</b>	M8 <b>X4</b>	N°38 <b>X1</b>



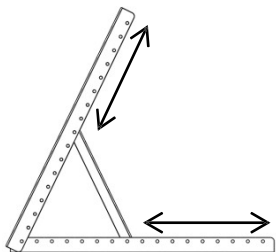



## UNIFIX 150 B

- Unifix dispone di un sistema d'inclinazione multi-posizione. Definire l'inclinazione desiderata in funzione dell'orientamento scelto.



Efficienza elettrica in funzione dell'inclinazione e dell'orientamento pannello				
	0° 	30° 	60° 	90° 
<b>Est</b>	93%	90%	78%	55%
<b>Sud-Est</b>	93%	96%	88%	66%
<b>Sud</b>	93%	100%	91%	68%
<b>Sud Ovest</b>	93%	96%	88%	66%
<b>Ovest</b>	93%	90%	78%	55%

- Fissare i 2 pezzi N°38 e N°37 in funzione dell'inclinazione scelta.

	M8x20 <b>X6</b>
	D8 <b>X6</b>
	M8 <b>X6</b>
	N°38 <b>X2</b>
	N°37 <b>X2</b>

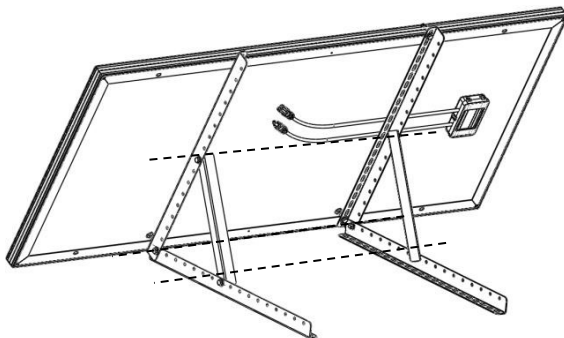

- Fissare il supporto sulla vostra superficie piana (suolo o muro rigido) con 10 viti adatte alla vostra superficie (viti e tasselli non forniti).

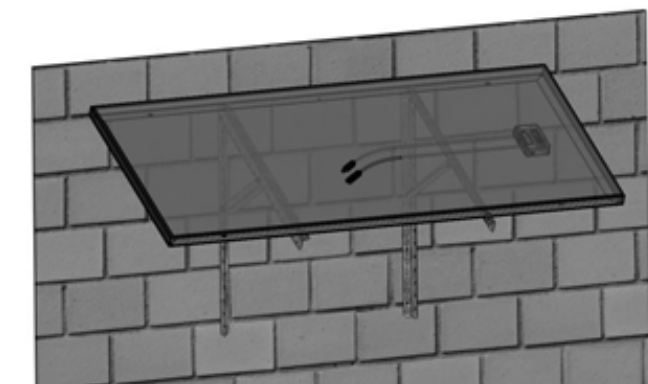

## GARANZIA

La garanzia copre difetti o vizi di fabbricazione per 1 anno, a partire dalla data di acquisto (pezzi e manodopera).

La garanzia non copre :

- la normale usura dei pezzi
- scorretto montaggio

In caso di difetto, restituire il prodotto al vostro distributore, con, in allegato :

- una prova di acquisto datata (scontrino, fattura...)
- una nota che spiega il difetto

Attenzione : il nostro servizio post vendita non accetta restituzioni porto assegnato

Dopo la scadenza della garanzia, il nostro servizio post vendita garantisce i ripari dopo accettazione di un preventivo.

Contatto servizio post vendita :

Uniteck-  
3 Avenue de L'Europe  
34310 Montady  
France  
mail: [sav@uniteck.fr](mailto:sav@uniteck.fr)  
Fax: +33 (0)4 88 04 72 20