

smarttune guide

For load display, see 'App Instructions', 'Gateway Install Guide' and 'Gateway Instructions' before sensor installation.

Product Description

smarttune is an innovative solution for accurate, live measurement of rigging load. Simple to retro-fit at the dock, smarttune makes repeatable standing rigging load data available through precision-designed, wireless technology. Designed to replace existing double acting turnscrews, it allows you to record and repeat your fast rig settings, creating the optimum sail shape and the best racing performance, in all conditions.

How it works...

Simply unthread the existing turnscrew and screw on smarttune. Easily connect the sensor to your phone via the latest smartphone app or to marine electronics via optional NMEA2000 Gateway for immediate load data.

Installation

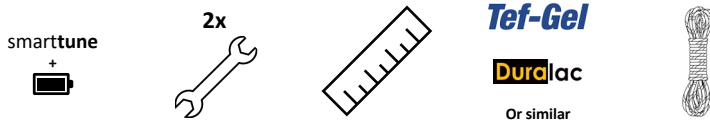

1. If installing smarttune with a gateway, follow 'Gateway install guide' before installing smarttune.
2. Release backstay & mainsheet completely, remove any mast shims and de-jack mast (if applicable).
3. Secure a halyard to a hardpoint near the chain-plate. Tension halyard until stay sag visible. Secure halyard and attach another halyard near chainplate as a safety.

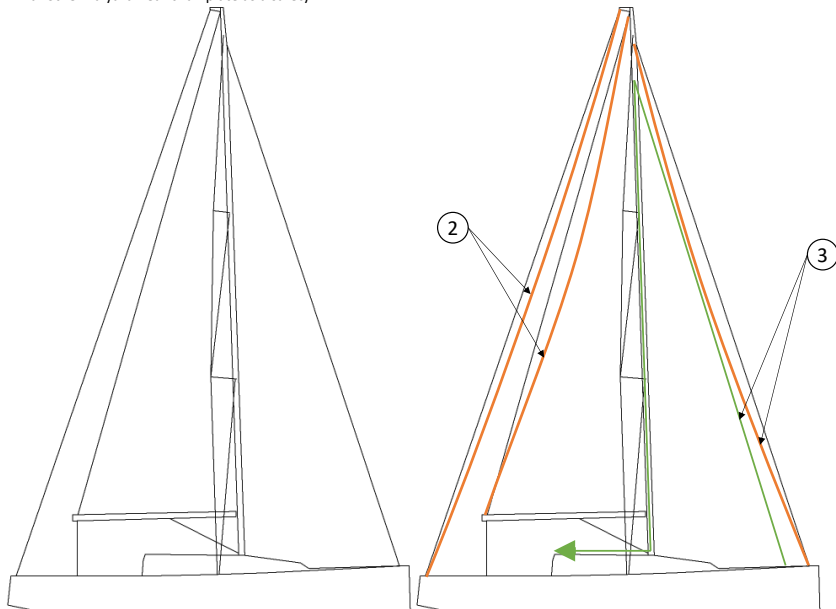

4. Remove split pins/Velcro from turnscrew studs.

5. Measure a reference stay length using ruler or verniers. e.g. distance between stud ends inside the turncrew.
6. Use rope to secure stay to a hardpoint.
7. Unscrew existing turncrew using the spanners. Ensure that stay is secure before completely disconnecting turncrew. Once the turncrew is free from the upper and the lower threads stay will hang.
8. Apply anti-corrosion paste to threads.
9. Locate smarttune turncrew and correctly orientate to chain-plate. The model/serial numbers should be the right way up when correctly oriented.
10. Looking down, rotate smarttune anti-clockwise onto stay stud. Take 3 complete turns onto stud.
11. Offer smarttune turncrew up to chainplate stud and continue winding anti-clockwise to thread. Use one spanner to hold stay stud still, and the other to rotate turncrew.
12. Thread turncrew on until reference measurement taken in step 5 is reached.
13. Reinstall any split pins/Velcro.
14. Remove rope securing the stay and halyards.
15. Return rig to dock tune as desired. Go sailing!

Changing Batteries

It is highly recommended that the batteries are changed in a dry, enclosed location e.g. below decks where possible. Cyclops recommends removal of the battery from the device and storage of the sensor in a cool, dry place away from direct sunlight during extended periods of time where it is not expected to be used.

FAILURE TO MAINTAIN THE BATTERY COVER SEAL WILL RESULT IN WATER INGRESS & PERMANENT DAMAGE NOT COVERED UNDER WARRANTY.

The sensor will show 0.00 as the load (even when under load) when the batteries need to be replaced.

Please dispose of used batteries responsibly.

5/16" Only

Removing battery & cover

Use a coin that fills the battery cover slot and twist until the cover pops out and comes completely free. If necessary, free the battery with a gentle tap to the opposite face of the sensor.

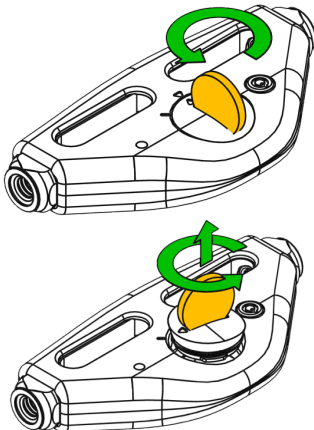

Replace the CR2032 battery with equivalent. Do not use non-standard batteries or other sizes, as this can cause damage.

Cyclops recommends Renata CR2032 batteries for maximum battery life and performance.

Replacing battery & cover

To reinstall the battery & cover, install battery +ve side up, insert cover, line up the arrow on the cover with the diagonal dash on the housing. Press firmly so the cover is flush with the housing. Use a coin to twist the cover until the arrows in the cover are aligned, and the battery cover is flush with the housing.

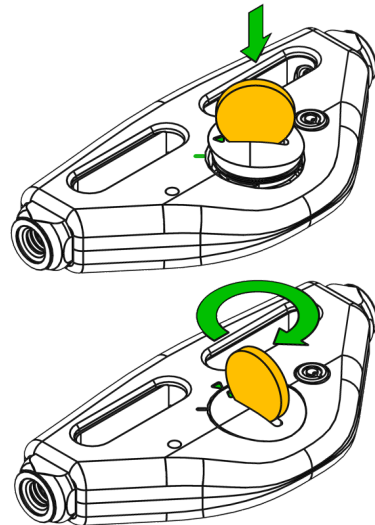

7/16" and above

Carefully remove each of the battery covers on the side of the sensor by unscrewing 2x Phillips head screws with a small Phillips screwdriver.

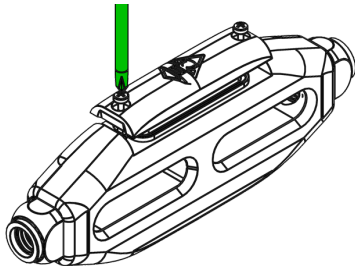
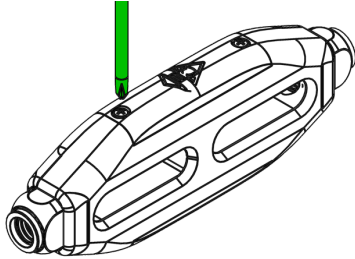

Lift off the plastic battery cover and place down without disturbing the seal on the body.

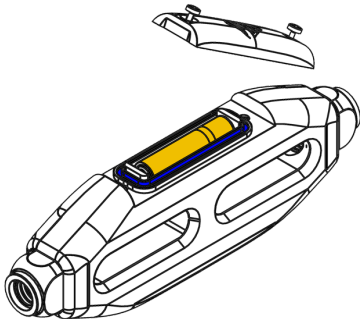

Check the 'O' ring seal (shown in blue) is seated properly and re-lubricate if dry.

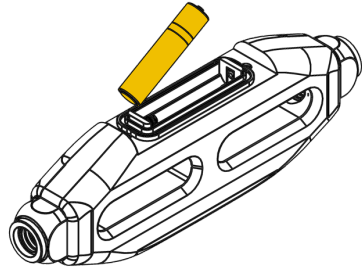

Remove the old batteries and replace with 2x new AAA.

Replace the plastic battery cover and carefully locate the 2 screws, tightening until the battery cover and screws are flush. **DO NOT OVER TIGHTEN THE SCREWS.**

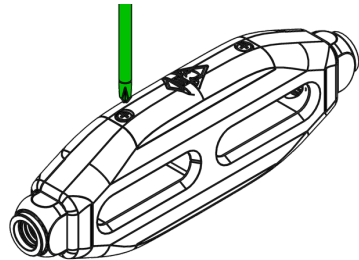
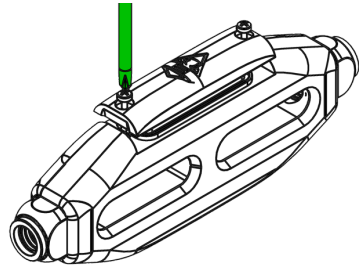



Safety

Please read all instructions before using **smarttune** to measure loads. Always perform a safety evaluation before use to ensure that use of the sensor is not dangerous to nearby people or property.

Overload

The Maximum Working Load (MWL) of a **smarttune** must not be exceeded, as this may cause damage to the internal instrumentation and will invalidate the warranty.

OVERLOADING TO 150% OF MWL WILL RESULT IN PERMANENT DAMAGE TO THE SENSOR THAT WILL REQUIRE RECALIBRATION.

Calibration

If **smarttune** has been under load for a significant length of time, the sensor may take 1-2 minutes to return to zero when the load is removed. This is to be expected.

Operation of sensor

Please note that **smarttune** is designed to work in tension only, with the load applied by studs threaded into the turnscrew.

Any loads applied to the plastic body (e.g. squeezing due to sails furled tightly around the sensor), may result in unexpected or incorrect reported loads, including negative loads. This is to be expected, and provided the sails do not cause physical damage to the plastic body, the sensor will continue to report the loads correctly when the squeezing is removed (i.e. when the sail is unfurled).

Technical Data

Frequency 1Hz (custom available on request)

Accuracy $\pm 1\%$ of MWL within 0-40°C

Body Material SS 316L, Brass threaded inserts

Housing Material Acetal, IP67 rated

Battery life 200 hours, 1x CR2032 (5/16")

life 6 months, 2x AAA (7/16" & above)

Thread	Dimensions mm	Mass g	MWL tonnes	Accuracy range* kg
5/16"	112x55x18	180	0.75	± 8
7/16"	165x61x26	390	1.6	± 16
1/2"	165x61x26	390	2.0	± 20
5/8"	83x66x22	620	4.0	± 40
3/4"	93x74x25	1000	8.0	± 80

smarttunes are not warranted to be accurate for the purposes of buying/selling products by weight.